



GFB DV+ T9353

INSTRUCTION MANUAL



Go Fast Bits P/L
2 Norman St
Peakhurst NSW 2210
Australia



Ph: +61 (0)2 9534 0099
Fax: +61 (0)2 9534 3999
Email: sales@gfb.com.au
Web: www.gfb.com.au

INSTALLATION

A video version of these instructions can be found on the GFB website here:

www.gfb.com.au/downloads/gfb-tv

- Remove the turbo intake pipe by loosening the clamps at each end and on any associated hoses.

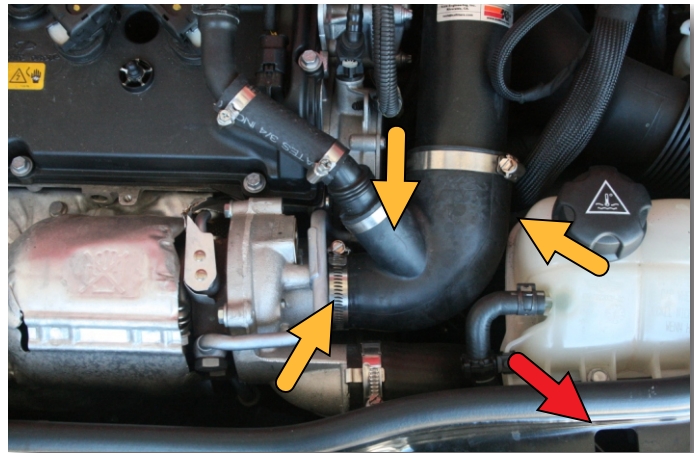

- Undo the bolt retaining the water reservoir (→), and swing it out of the way. Use a zip tie through the hole shown (→) to hold it in place so you can work underneath.



- The factory diverter valve solenoid is located on the front of the turbo compressor cover.

Unclip the electrical connector (→), then remove the 3 screws (→) holding it on using a 5mm metric hex key. Remove the diverter from the car.

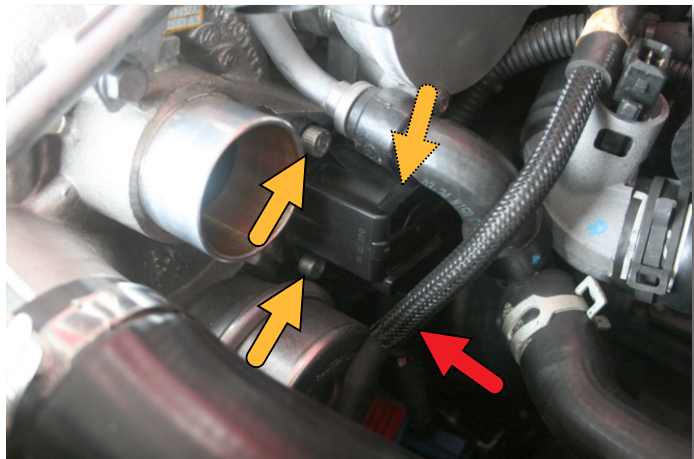

It may also help to remove the wastegate actuator hose (this is the one covered with braid in the foreground) to give you a little more space to work.

- Now separate the factory valve mechanism from the solenoid coil by pulling on the plastic diaphragm shroud - the whole assembly will pop off leaving the bare solenoid coil.

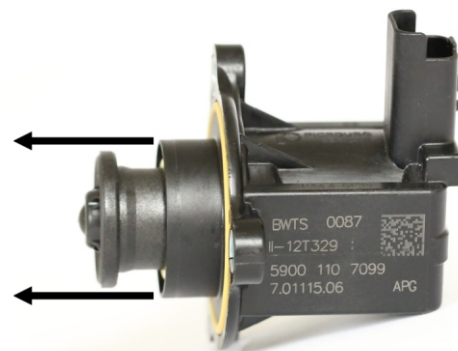

INSTALLATION - CONTINUED

- Install the GFB parts onto the solenoid as shown below, making sure to use the supplied spring, the factory screws, and the factory yellow o-ring, then set this assembly aside:

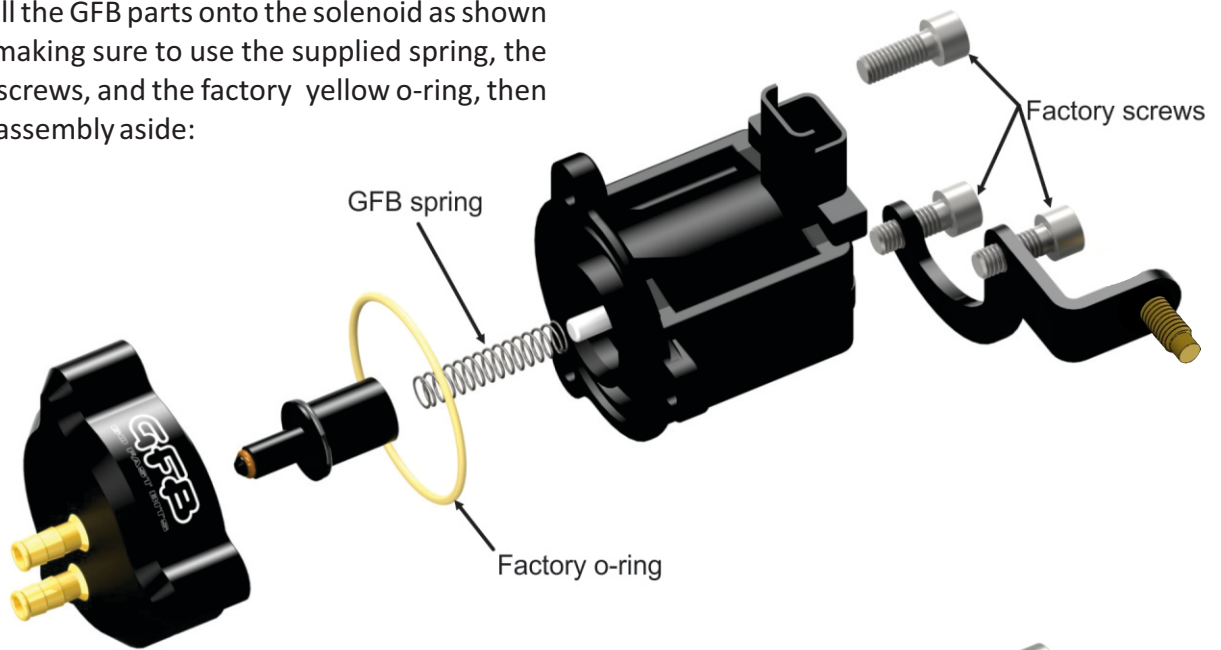

- Install the main spring and piston into the valve body as shown, using a smear of engine oil on the piston (the black o-ring comes already installed in the groove).

Note that the DV+ can also be installed without the main spring, please see notes at the end of these instructions, under the heading titled "Using The Main Spring".

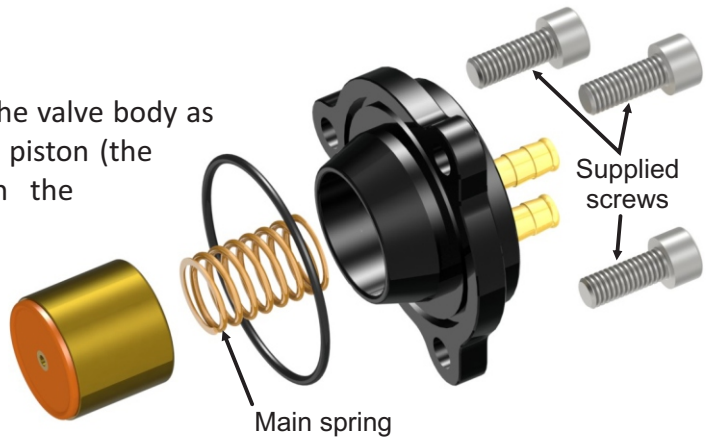

- Install the body/piston assembly onto the turbo compressor cover in the same location as the factory diverter, using the supplied screws. Make sure to hold the piston into the body with your finger during this process so the piston doesn't fall out.

Note that the positions of the bolt holes will allow it to fit in only one orientation (engraved logo will be upright).



- Cut the supplied hose into two equal lengths (it can be trimmed shorter if required at a later stage, so just cut it in half for now). These will be used to join the hose tails on the valve body to the solenoid assembly.

INSTALLATION - CONTINUED

- Install the solenoid assembly onto the car – Find the blue lambda sensor plug that is located underneath the turbo and remove it from the metal bracket. Re-locate it to the spare hole on the same bracket, slightly toward the rear of the engine bay (shown by the red arrow below).

The picture below is shot from deep inside the engine bay, looking forwards to the radiator fan. The turbo is just outside of frame, top right (the wastegate actuator however is visible).

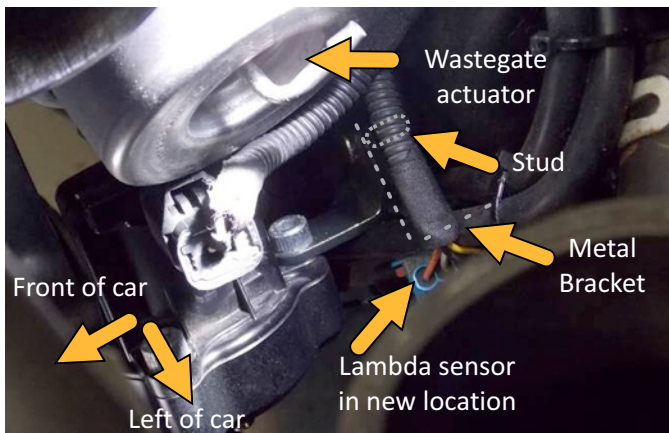
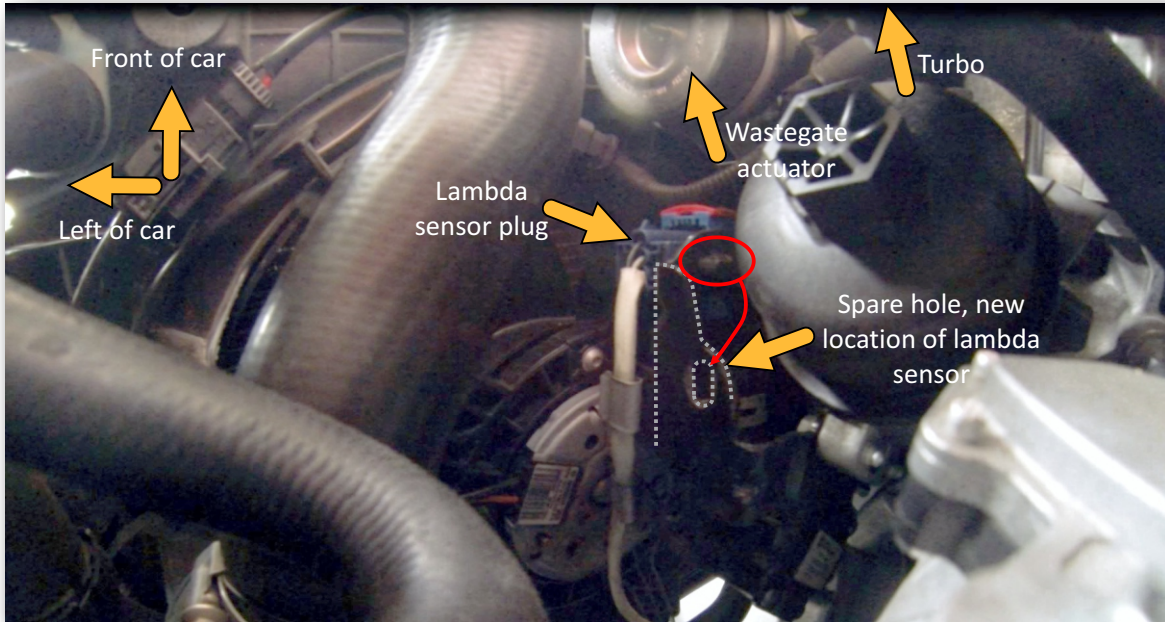

Orient the solenoid so that the electrical connector is facing upwards and towards the left of the vehicle, and the hose tails point downwards and left. Insert the threaded stud of the solenoid mounting bracket into the hole that the lambda sensor was using and secure with the supplied locknut.

Connect the two hoses from the valve body onto the two hose tails on the solenoid assembly, making sure to connect port A to

A, and B to B (i.e. centre port to centre port, and outside port to outside port).

- Plug the electrical connector into the solenoid, and if you disconnected the wastegate actuator hose, make sure to re-connect it.
- Re-install the radiator reservoir and turbo intake pipe.

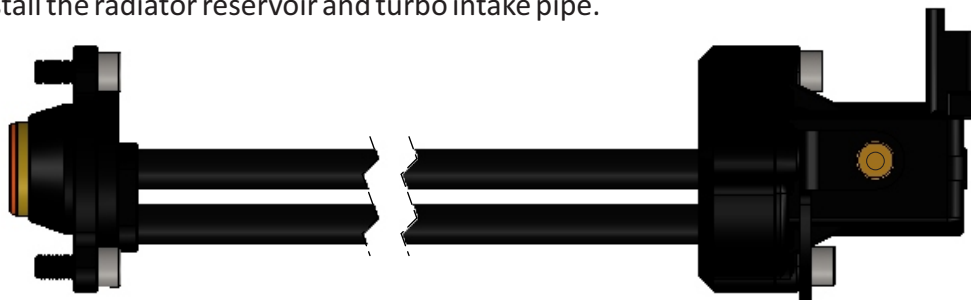

USING THE MAIN SPRING

The DV+ is designed such that it can operate in two modes, depending on whether the main spring is installed or not. Installing the main spring means the DV+ can open and close progressively in response to how much boost pressure is present when the ECU energises the solenoid - this is where the TMS benefit comes from. Because this operation method is different from the OE diverter, it is not unusual to hear a different sound from the intake when lifting off the throttle at low RPM, especially if you have an aftermarket intake or a larger turbo installed.

Whilst this does not indicate a faulty product or cause any issues to the turbo or engine, if the noise is objectionable, you can choose to remove the main spring from behind the piston. This will make the DV+ operate like the factory diverter, i.e. either open or shut - it will not open or close progressively in response to boost pressure.

Removing the main spring will eliminate different sounds at low RPM. The TMS benefit is lost however, but the DV+ will still hold boost without the main spring.

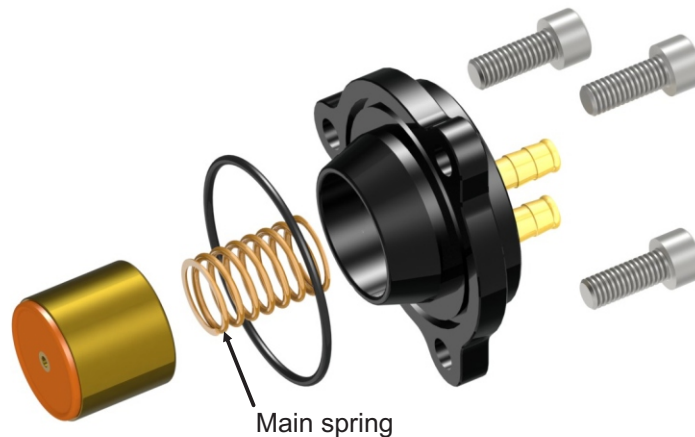

This product is intended for racing use only, and it is the owner's responsibility to be aware of the legalities of fitting this product in his or her state/territory regarding noise, emissions and vehicle modifications.

GFB products are engineered for best performance, however incorrect use or modification of factory systems may cause damage to or reduce the longevity of the engine/drive-train components.

GFB recommends that only qualified motor engineers fit this product. Warranty is for the period of one year from the date of purchase and is limited only to the repair or replacement of GFB products provided they are used as intended and in accordance with all appropriate warnings and limitations. No other warranty is expressed or implied.

WHAT TO EXPECT FROM YOUR DV+

The DV+ is designed to offer three key improvements over the OE diverter:

Longevity:

The DV+ will outlast the factory diverter - if you've ever replaced a factory diverter, chances are it won't be your last, especially if you run higher boost. Fitting a DV+ is good insurance and pays for itself the first time a factory diverter fails.

Boost holding:

The factory diaphragm diverter valves typically do seal well, until they begin to fail - which is almost assured on a tuned engine. The failure can begin as a small tear in the diaphragm, which can enlarge over time to become a significant leak.

The DV+ will seal properly even up to 35psi, ensuring all of your hard-earned boost gets to the engine. Of course, the performance benefits you notice from the driver's seat will depend entirely on the condition of the factory diverter you replace. For example, if your factory valve is not (yet) leaking, there will be no change to your peak boost.

However, if your factory diverter is beginning to fail and is leaking a small amount, installing a DV+ may show the same peak boost, but with an improvement in the amount of boost held to redline. This is because a small leak is easily overcome by the turbo in the mid-range, but at higher RPM as the turbo runs out of flow, a small leak can lead to a more noticeable drop in boost pressure. In this instance, the DV+ will result in less boost drop-off at high RPM.

Finally, if your factory valve is leaking significantly, fitting the DV+ will result in higher peak boost pressure, as well as significantly less drop-off at high RPM.

Throttle response:

When using the DV+ with the main spring installed, it will preserve as much boost pressure as possible when the throttle is lifted. This means that when you lift off to shift, or when you balance the car with the throttle mid-corner (using slight on-off-on throttle modulation), the DV+ can help recover boost faster when the throttle is re-opened.

What the DV+ can't do however, is *create* more boost, or cause the turbo to spool faster. Quite simply, whatever boost the turbo makes, the DV+ will deliver to the engine, and it will also preserve as much boost pressure as possible during a brief throttle lift-off, which is where the faster boost recovery comes from. If there is no boost to preserve, or if boost still drops off at high RPM, that is simply highlighting the limitations of the turbo.

THE DV+ DIFFERENCE

Whilst the DV+ might simply look like a metal replacement valve, there is a significant difference in the way it operates compared to the factory diverter - and other aftermarket diverters for that matter.

The factory diverter uses the solenoid to directly actuate the valve. The problem with this is the actuating forces are very weak – the return spring is weak, and the solenoid coil is weak when the valve is fully closed because of the long stroke (magnetic force diminishes significantly as distance increases). So increasing the spring pre-load of the factory valve doesn't help, since the solenoid coil will struggle to open the valve.

The GFB DV+ uses the factory solenoid coil, but its role is to control the pressure signal used to actually open and close the piston, which is known as “pilot actuation”. This means the forces that the solenoid coil deals with are much lower, and its operation is therefore reliable even at much higher boost pressure. The solenoid operates a plunger that controls pressure to the back of the piston. When the solenoid is off, there is equal pressure on both sides of the piston, but importantly, the area the pressure acts on is about 25% LARGER on the back of the piston than the front. So there is 25% more force holding the piston shut than there is pushing it open. The bottom line is, it doesn't matter how much boost you run, the DV+ will never crack open.

When the solenoid activates, the pressure on the back of the piston is relieved, and it can then open. The benefits of this system are reliable valve actuation at high boost, no leakage, and being all metal parts, no failures due to increased temperature.

Because the DV+ has a higher closing force than opening force, it doesn't actually NEED a return spring behind the piston to work – it will open and shut, and hold boost, just as reliably with or without the spring.

However, using the spring means that unlike the factory diverter, the GFB DV+ piston can open and close progressively in response to both boost pressure AND the ECU signal operating the solenoid. That is, if the solenoid is triggered but there is no boost, it won't open. If the solenoid is triggered and there is boost, the valve will open only as long as there is boost pressure pushing it open. It will close itself as boost pressure in the intercooler drops, even if the ECU is telling it to open. This operation method results in less turbo lag, because the valve is not opened unnecessarily.

This is the basis behind GFB's TMS principle; turbo lag is minimised when the valve only vents just enough air to prevent compressor surge. Venting more air than necessary only increases the time it takes boost to recover after a gearshift, as illustrated by the graph opposite.

To read more about the TMS principle, scan the QR code below:

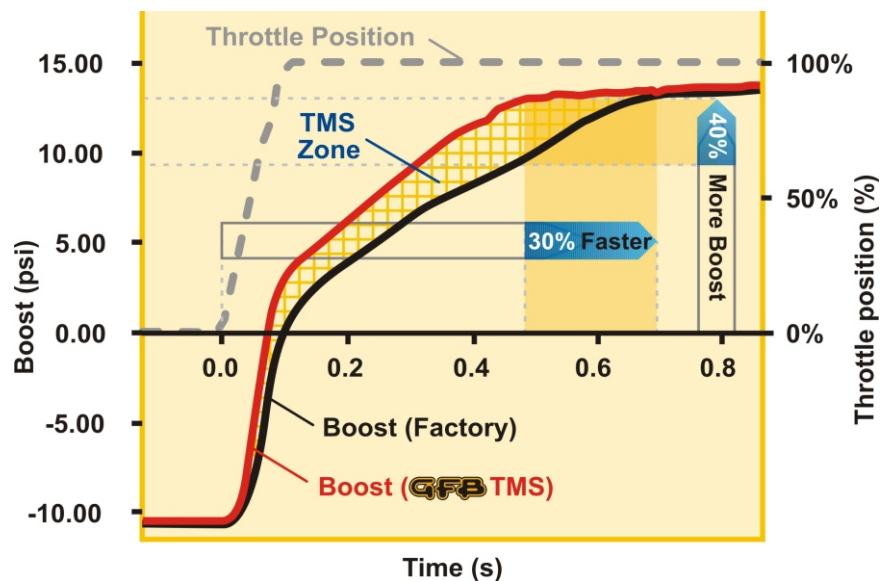

Or visit: www.gfb.com.au/tech/tech-articles/13-turbo-lag-and-the-turbo-management-systems-solution

IMPORTANT! All GFB pistons are checked for fitment and tolerance before shipment. Please do not drop the GFB piston onto a hard surface as this may cause (invisible) damage that could result in boost leaks or sticking.

WICHTIG! Alle Kolben wurden vor Versand auf Freigängigkeit geprüft. Bitte achten Sie bei der Montage darauf, dass *der Kolben nicht auf den Boden fällt*, da dieser schon bei kleinster (evtl. Nicht sichtbarer) Beschädigung zur Undichtigkeit oder Kolbenklemmen führen kann!